

logistics details

Product title:	Aluminium terminals longitudinally sealed KRA type
Type:	KRA 70/12 (100 SZT./PCS)

Certificates

Design	DIN 46329
--------	------------------

crimping

Die code No.	18
No. of crimping wide	3
No. of crimping narrow	6

mechanical details

Material	Al.
Surface	uncoated
Size of bolt dia	M12
DIN	✓

Sections

Cross section re [mm ²]	95
Cross section rm/sm [mm ²]	70

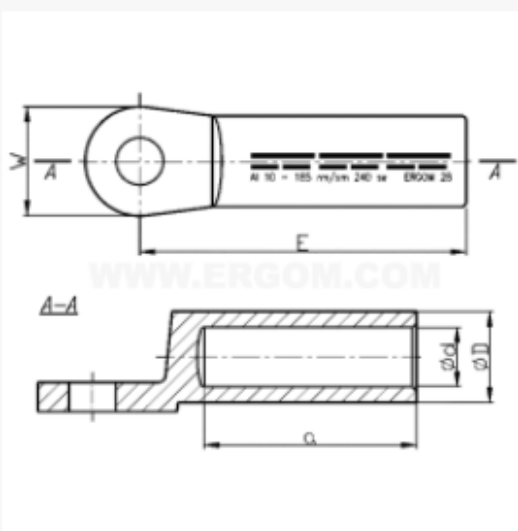

Sizes

d	11,2
D	18,5
a min	52
E	72
W	25