

logistics details

Product title:	Aluminium terminals longitudinally sealed KRA type
Type:	KRA 50/12 (100 SZT./PCS)

Certificates

Design	DIN 46329
--------	------------------

crimping

Die code No.	16
No. of crimping wide	3
No. of crimping narrow	5

mechanical details

Material	Al.
Surface	uncoated
Size of bolt dia	M12
DIN	✓

Sections

Cross section re [mm ²]	70
Cross section rm/sm [mm ²]	50

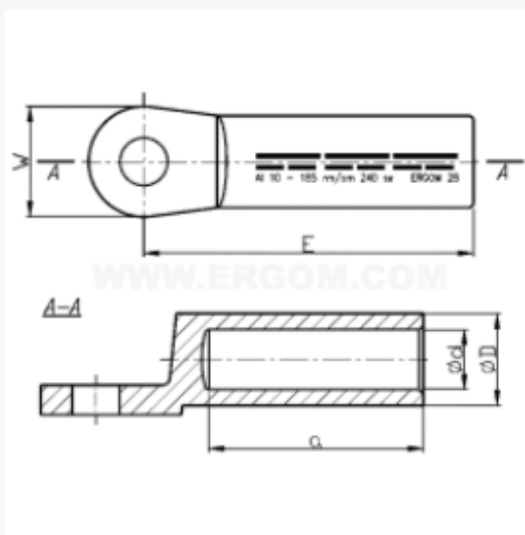

Sizes

d	9,8
D	16,0
a min	42
E	62
W	25