

logistics details

Product title: **Low-cost tubular terminals with inspection hole KREo type**

Type: **KREo 50/8 (100 SZT./PCS)**

Weight netto: **~ 1,905 kg**

Certificates

Design **economic**

crimping

Die code No. **13**

No. of crimping wide **1**

No. of crimping narrow **2**

mechanical details

Material **Cu**

Surface **tin-plated**

Size of bolt dia **M8**

Sections

Cross section rm/sm [mm²] **50**

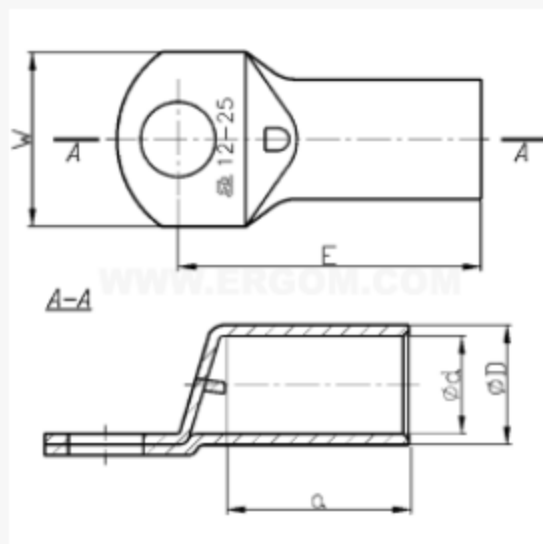

Sizes

d	9,5
D	12,5
a	21,5
E	36,7
W	18,0